

# PRODUKTZEICHNUNG

SIG SAUER P320 CO<sub>2</sub>

# SIG SAUER®

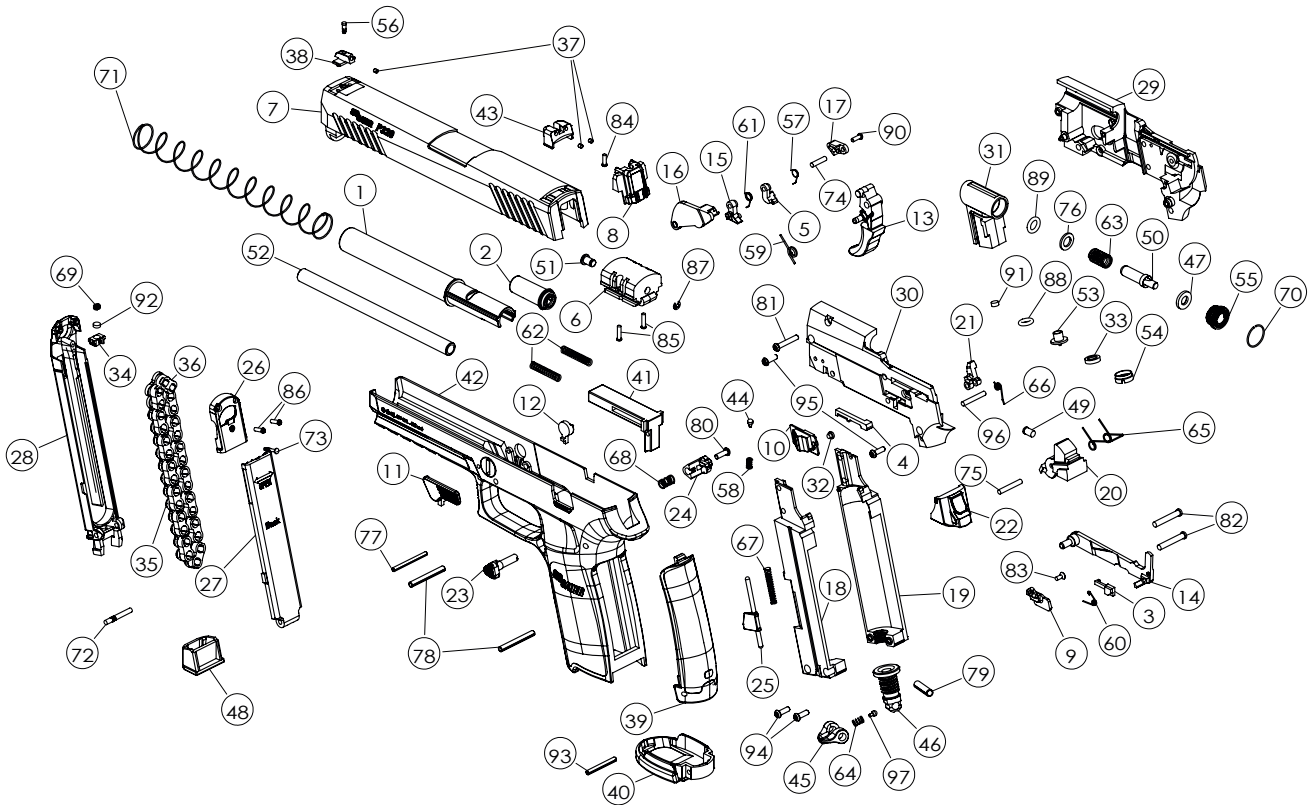

No.	Name of Parts	No.	Name of Parts	No.	Name of Parts	No.	Name of Parts
1	Outer Barrel	27	Magazine Rear Cover B	53	Pierce Pin	78	Mechanism Frame Spring Pin
2	Barrel Base	28	Magazine Front Cover	54	Pierce Cap	79	Puncture Screw Spring Pin
3	Inner Safety Right	29	Mechanism Frame Right	55	Valve Cap	80	Magazine Catch Screw
4	Inner Safety Left	30	Mechanism Frame Left	56	Front Sight Pin	81	Mechanism Frame Screw(Long)
5	Clip Stopper	31	Valve Body	57	Clip Stopper Spring	82	Valve Body Pin
6	Cylinder Block	32	Red Dot	58	Safety Plunger Spring	83	Slide Stop Screw
7	Slide	33	Pierce Seal	59	Trigger Spring	84	Slide End Screw
8	Slide End	34	Clip Click	60	Trigger Bar Spring	85	Cylinder Block Screw
9	Slide Stop	35	Clip Joint	61	Nail Spring	86	Magazine Rear Cover Screw
10	Safety Lever	36	Clip Piece	62	Buffer Spring	87	E-ring ETW-2
11	Take Down Lever Left	37	White Dot	63	Valve Spring	88	O-ring P-5
12	Take Down Lever Right	38	Front Sight	64	Puncture Screw Click Spring	89	O-ring P-6 Urethane
13	Trigger	39	Back Grip	65	Hammer Spring	90	Nail Arm Screw
14	Trigger Bar	40	Grip Bottom	66	Hammer Block Spring	91	Filter
15	Nail	41	Slide Block	67	Magazine Eject Spring	92	Magnet
16	Nail Arm A	42	Frame	68	Magazine Catch Spring	93	Back Grip Spring Pin
17	Nail Arm B	43	Rear Sight	69	Clip Click Spring	94	Puncture Frame Screw
18	Puncture Frame Left	44	Safety Plunger	70	Piston Ring	95	Mechanism Frame Screw (Short)
19	Puncture Frame Right	45	Puncture Screw Knob	71	Slide Return Spring	96	Hammer Block Pin
20	Hammer	46	Puncture Screw	72	Magazine Rear Cover B Pin	97	Puncture Screw Click
21	Hammer Block	47	Valve Seal	73	Magazine Rear Cover A Pin	98	Nail Assembly
22	Frame End	48	Magazine Bumper	74	Nail Pin	99	Back Grip Assembly
23	Magazine Catch Button	49	Hammer Pin	75	Hammer Pin	100	Valve Body Assembly
24	Magazine Catch	50	Valve Pin	76	Valve Washer	101	Slide Assembly
25	Magazine Release Bar	51	Hit Pin	77	Slide Block Spring Pin	102	Magazine Assembly
26	Magazine Rear Cover A	52	Inner Barrel				

# PRODUKTZEICHNUNG

SIG SAUER P365 CO<sub>2</sub>

# SIG SAUER®

## 98. Nail Assembly

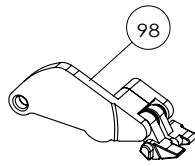

Assembled by  
 5. Clip Stopper  
 15. Nail  
 16. Nail Arm A  
 17. Nail Arm B  
 57. Clip Stopper Spring  
 61. Nail Spring  
 74. Nail Pin  
 90. Nail Arm Screw

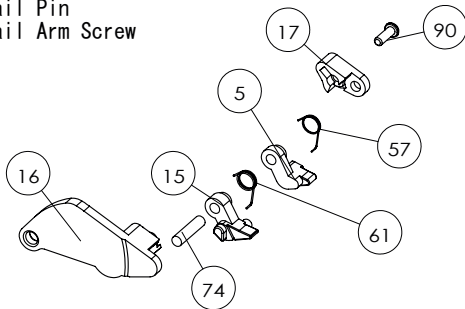

## 99. Back Grip Assembly

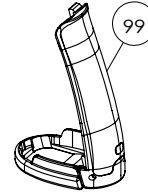

Assembled by  
 39. Back Grip  
 40. Grip Bottom  
 93. Back Grip Spring Pin

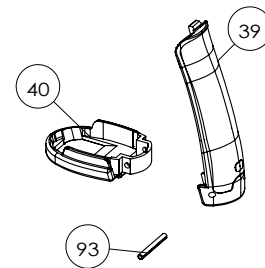

## 100. Valve Body Assembly

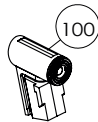

Assembled by  
 31. Valve Body  
 33. Pierce Seal  
 47. Valve Seal  
 50. Valve Pin  
 53. Pierce Pin  
 54. Pierce Cap  
 55. Valve Cap  
 63. Valve Spring  
 70. Piston Ring  
 76. Valve Washer  
 88. O-ring P-5  
 89. O-ring P-6 Urethane  
 91. Filter

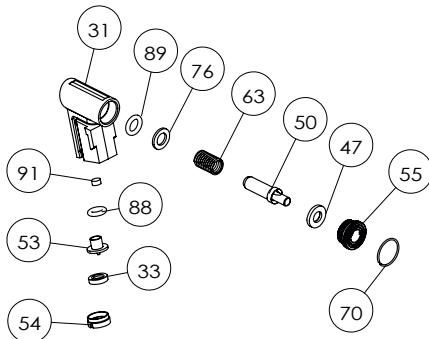

## 101. Slide Assembly

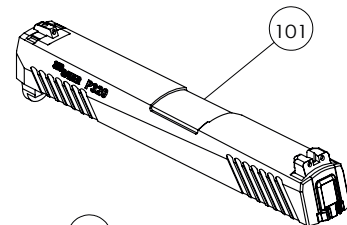

Assembled by  
 6. Cylinder Block  
 7. Slide  
 8. Slide End  
 37. White Dot  
 38. Front Sight  
 43. Rear Sight  
 51. Hit Pin  
 56. Front Sight Pin  
 84. Slide End Screw  
 85. Cylinder Block Screw  
 87. E-ring ETW-2

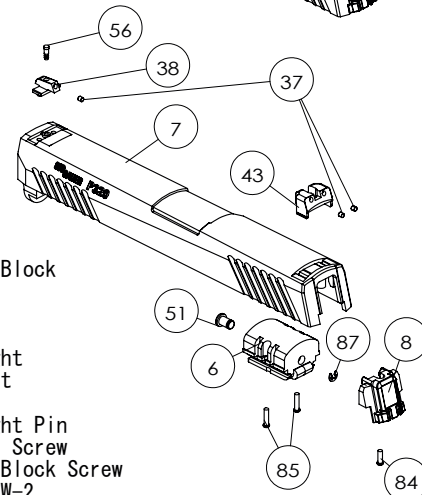

# PRODUKTZEICHNUNG

SIG SAUER P365 CO<sub>2</sub>

# SIG SAUER®

## 102. Magazine Assembly

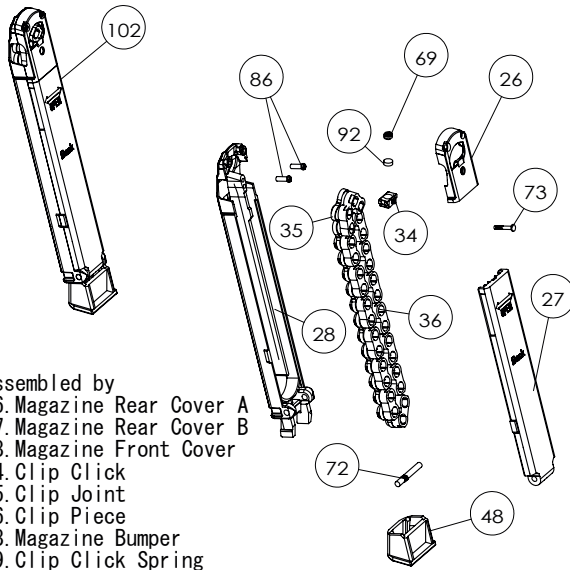

- Assembled by
- 26. Magazine Rear Cover A
  - 27. Magazine Rear Cover B
  - 28. Magazine Front Cover
  - 34. Clip Click
  - 35. Clip Joint
  - 36. Clip Piece
  - 48. Magazine Bumper
  - 69. Clip Click Spring
  - 72. Magazine Rear Cover B Pin
  - 73. Magazine Rear Cover A Pin
  - 86. Magazine Rear Cover Screw
  - 92. Magnet